

Beam Merging Experiment on STS-500 4/10/04
No MOV's included.

≤ 0.1J in any arc (but no current limit)

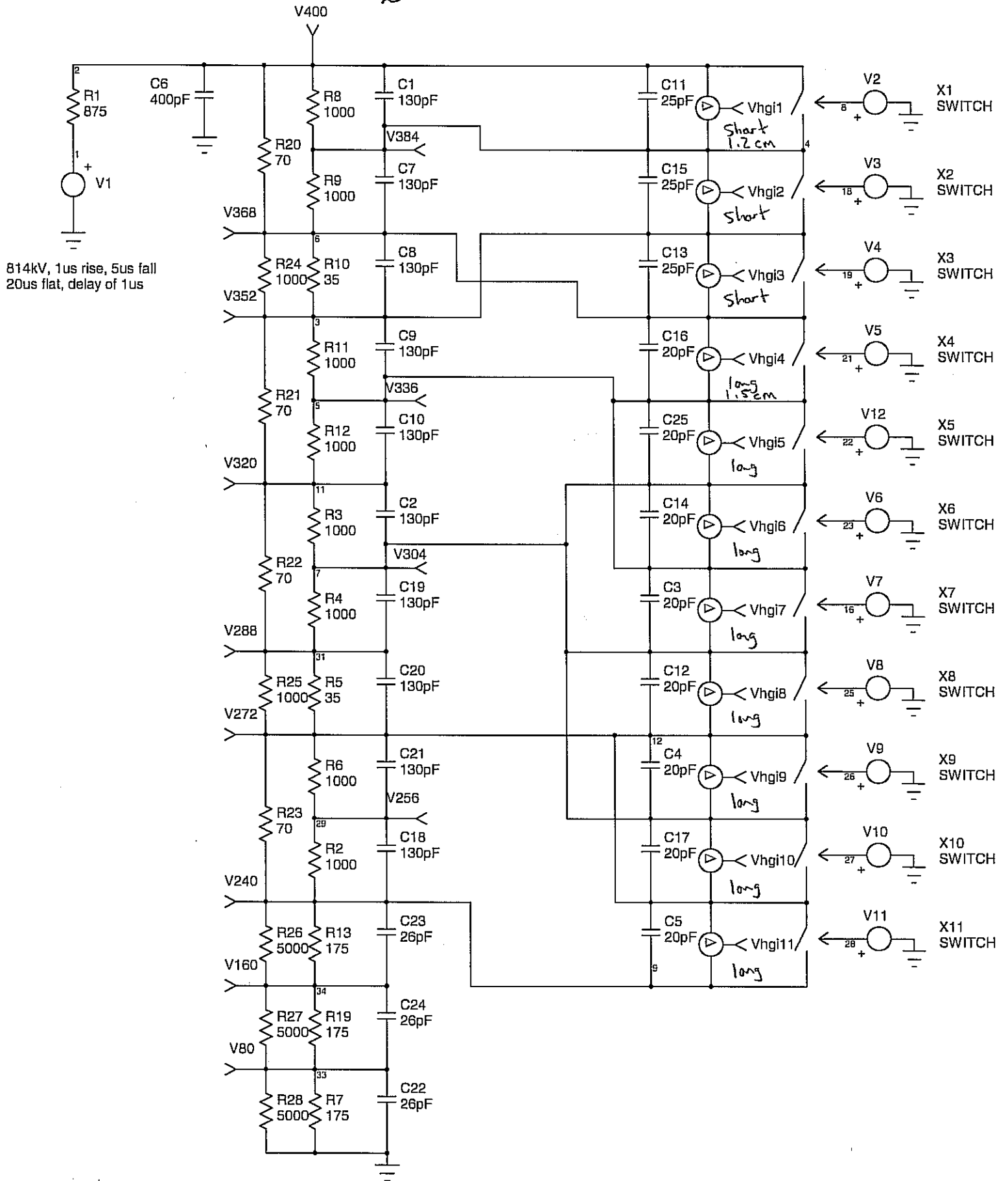

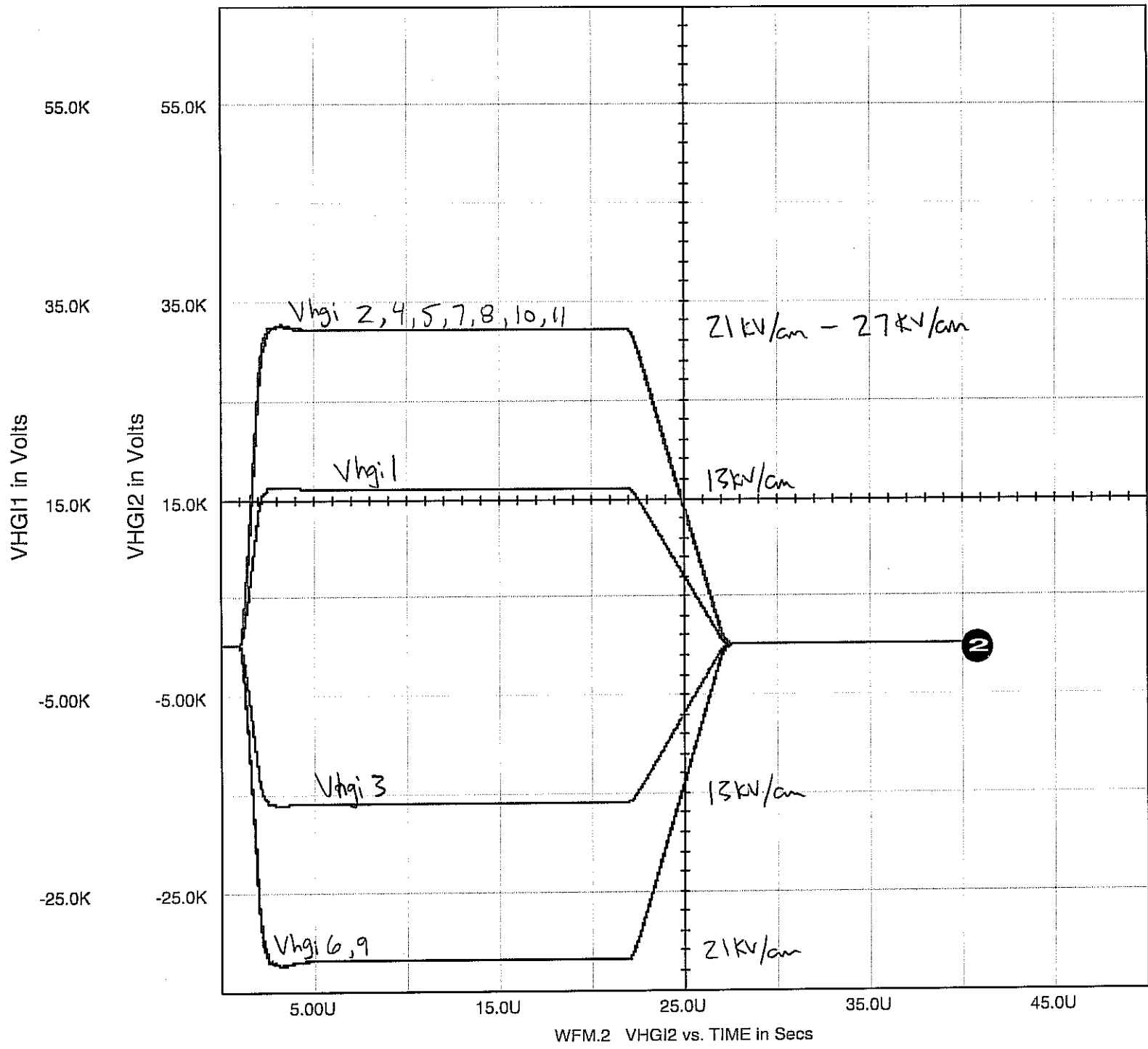

WFM.2 VHGI2 vs. TIME in Secs

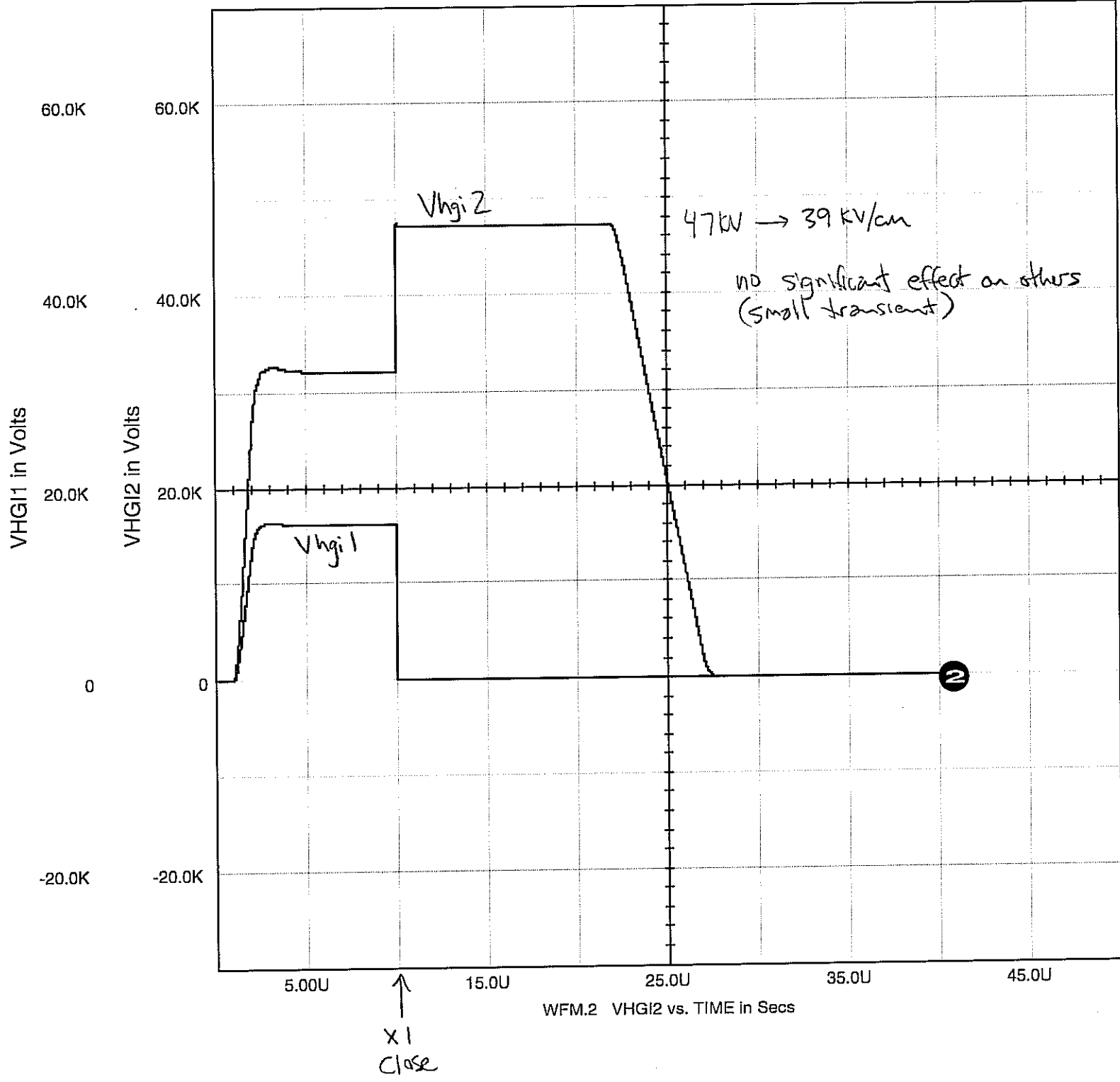

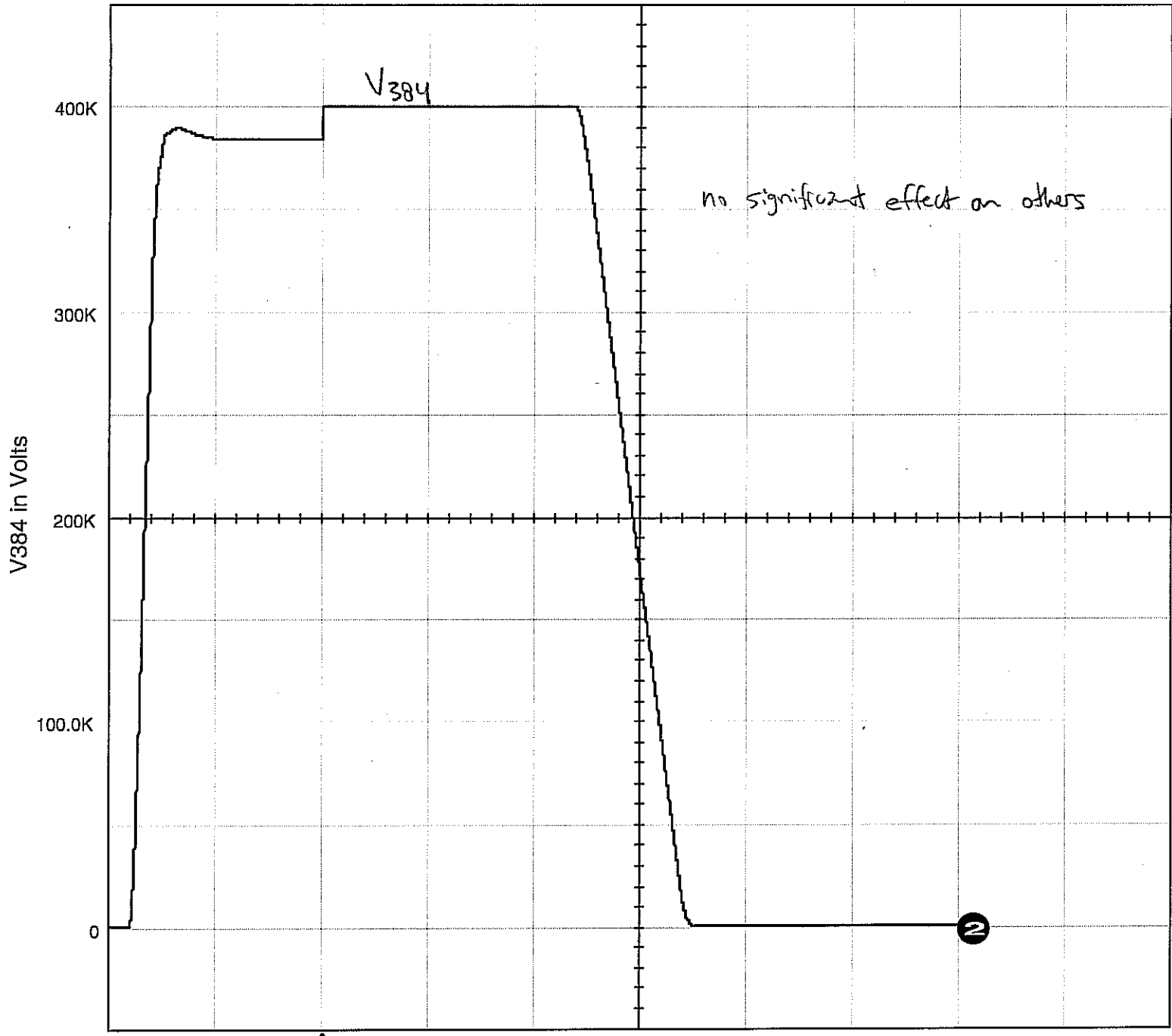

no significant effect on others

V384

2

x1
close

WFM.2 V384 vs. TIME in Secs

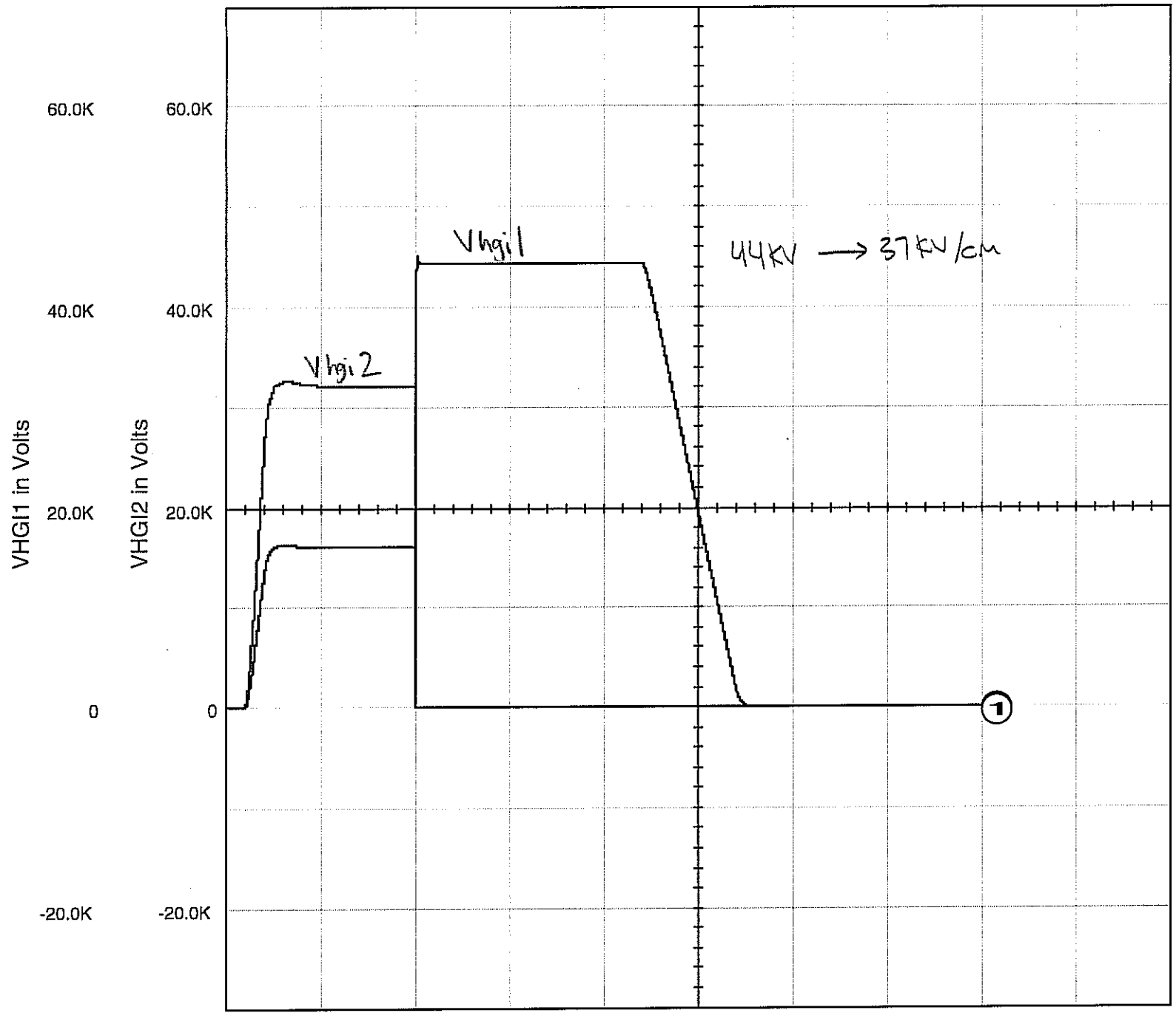

WFM.2 VHG12 vs. TIME in Secs

↑
X2
close

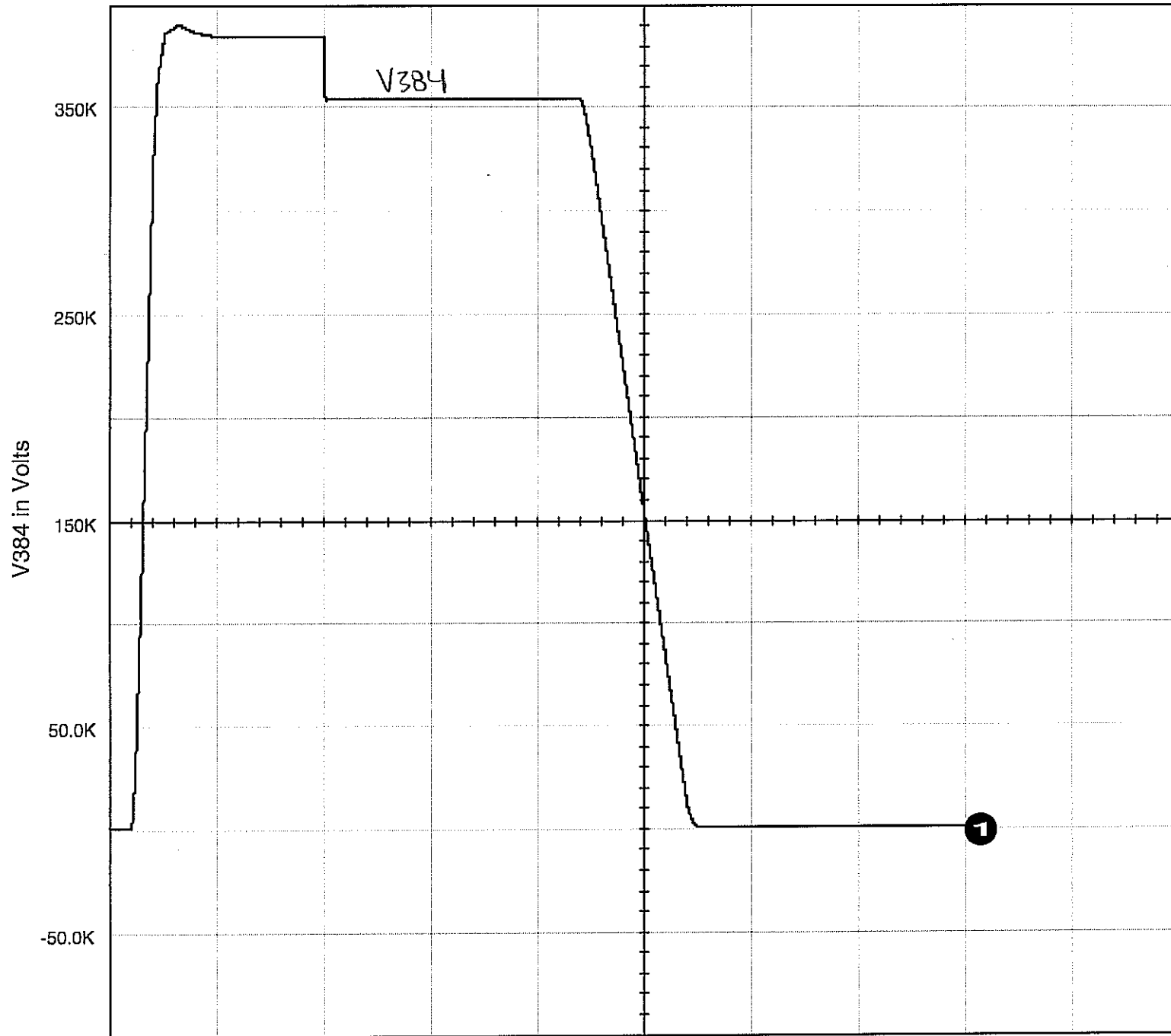

WFM.1 V384 vs. TIME in Secs

↑
x2
close

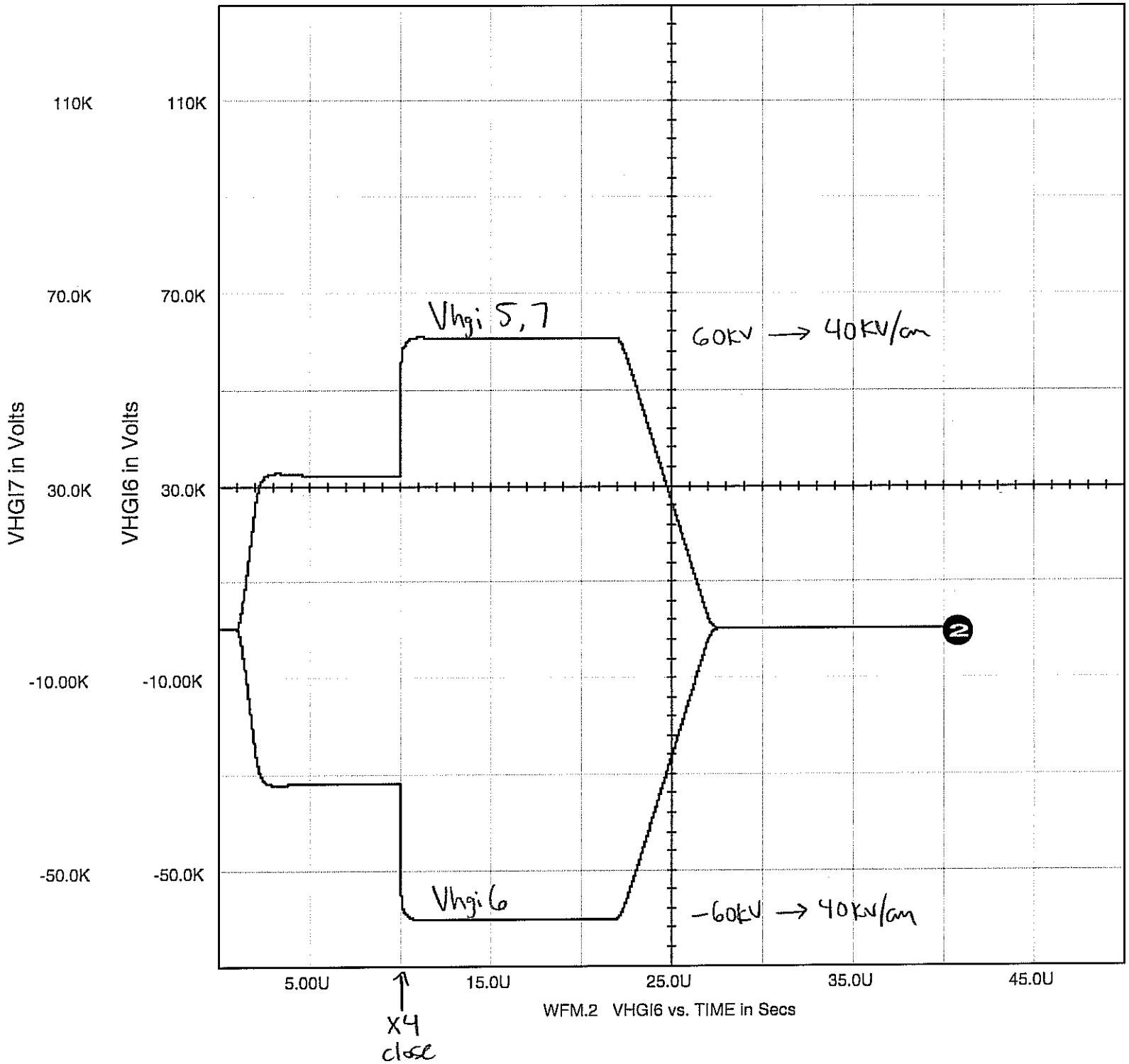

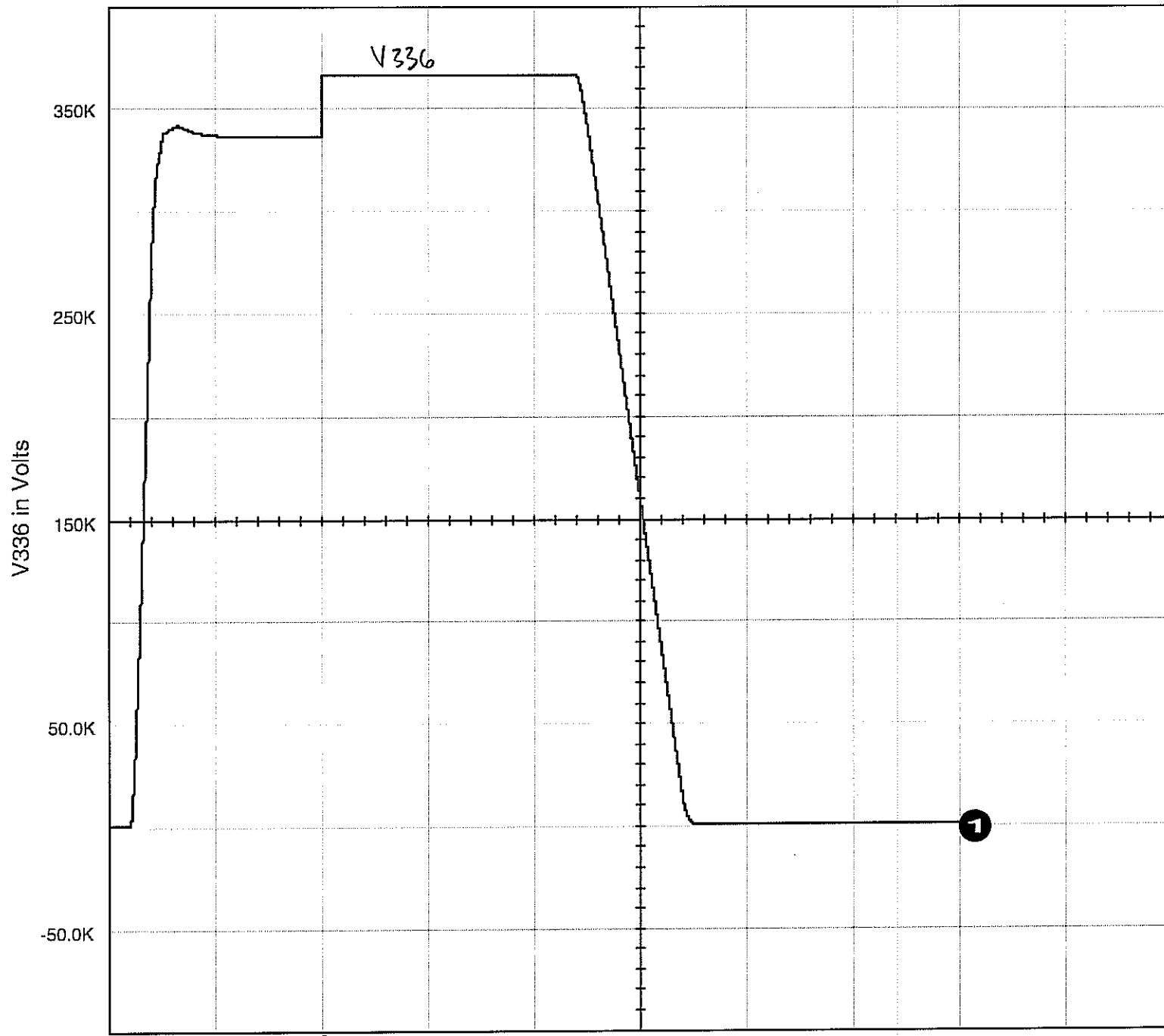

WFM.1 V336 vs. TIME in Secs

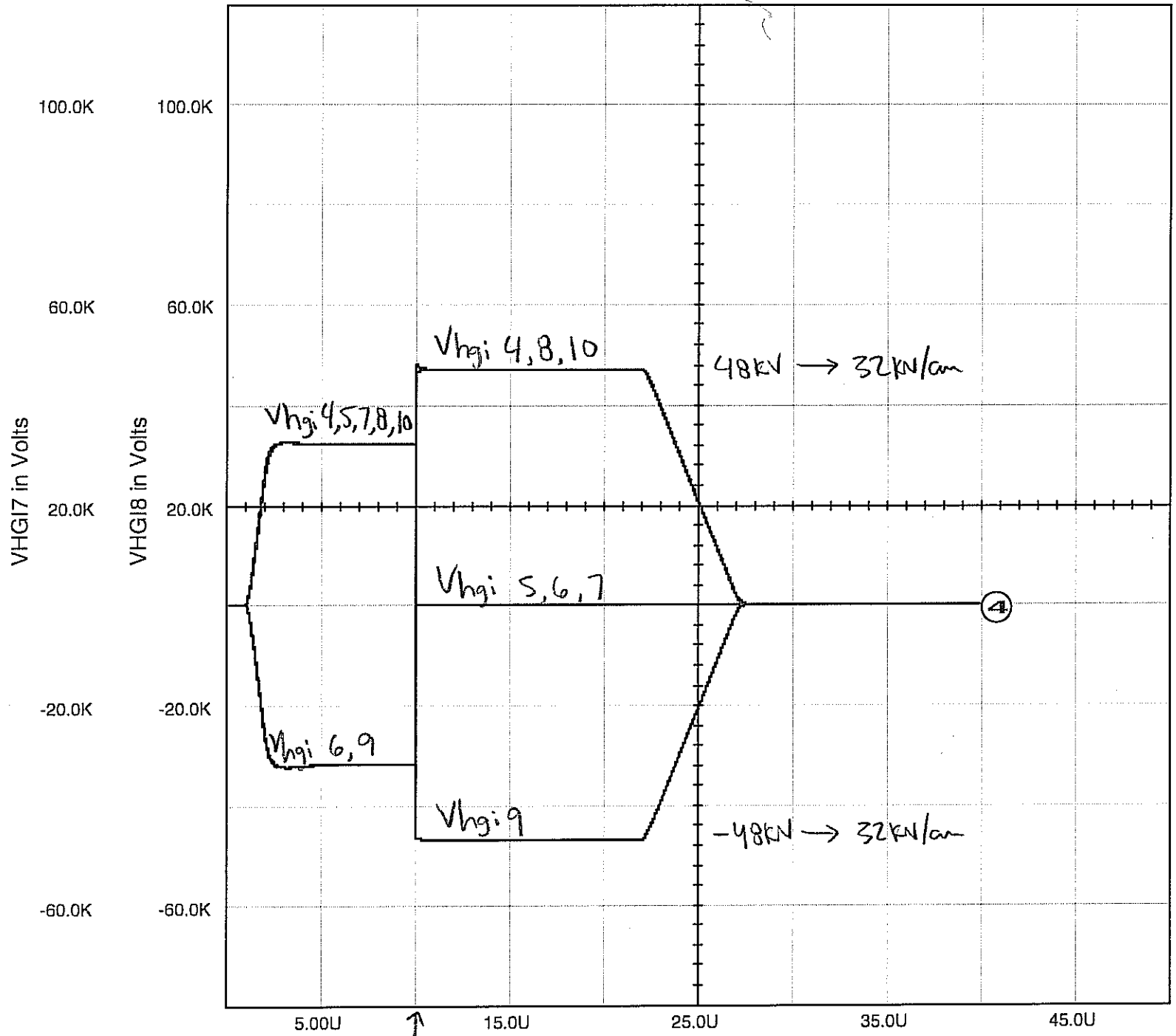

↑
x5
close

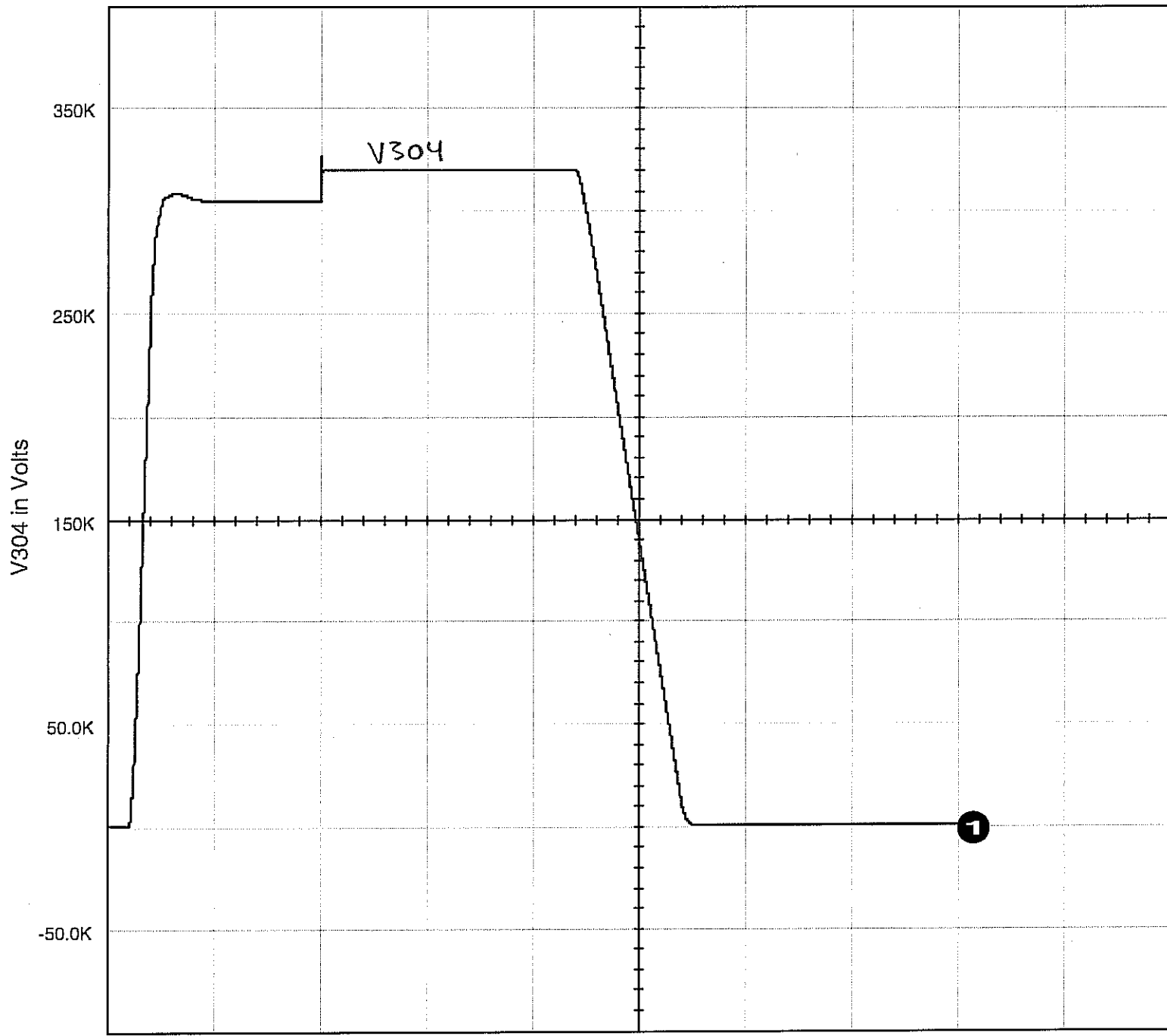

WFM.1 V304 vs. TIME in Secs

↑
x5
close

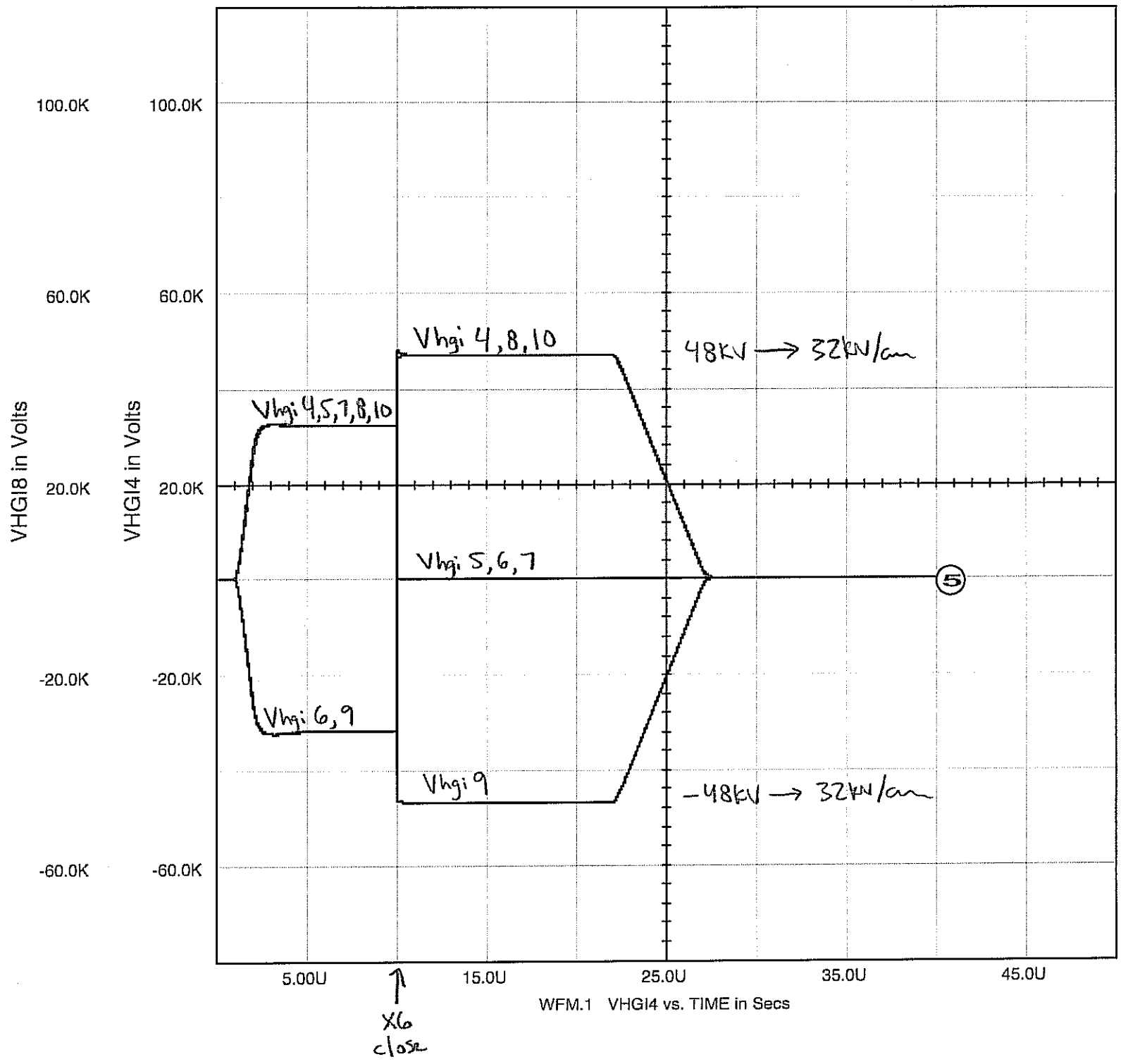

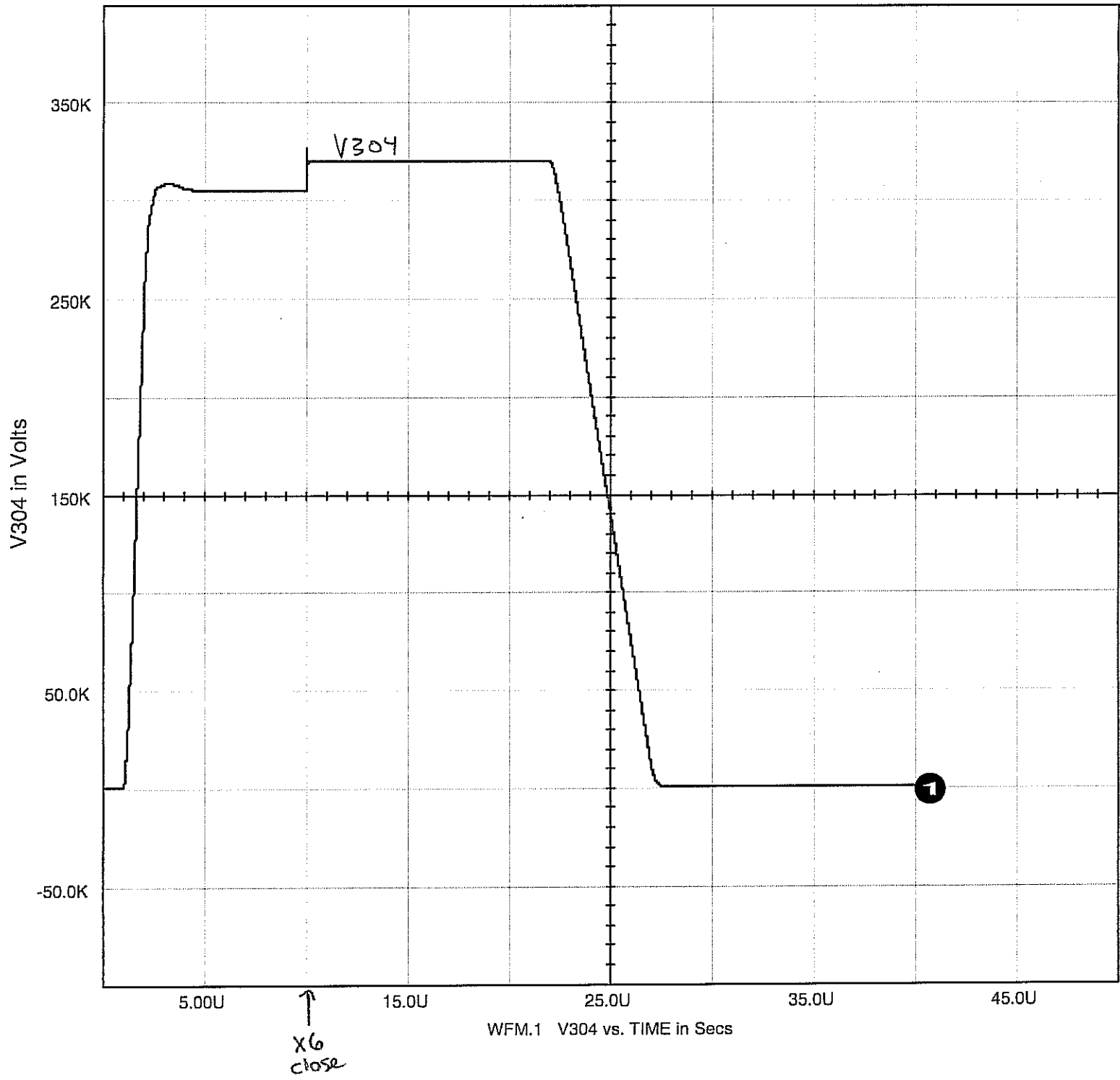

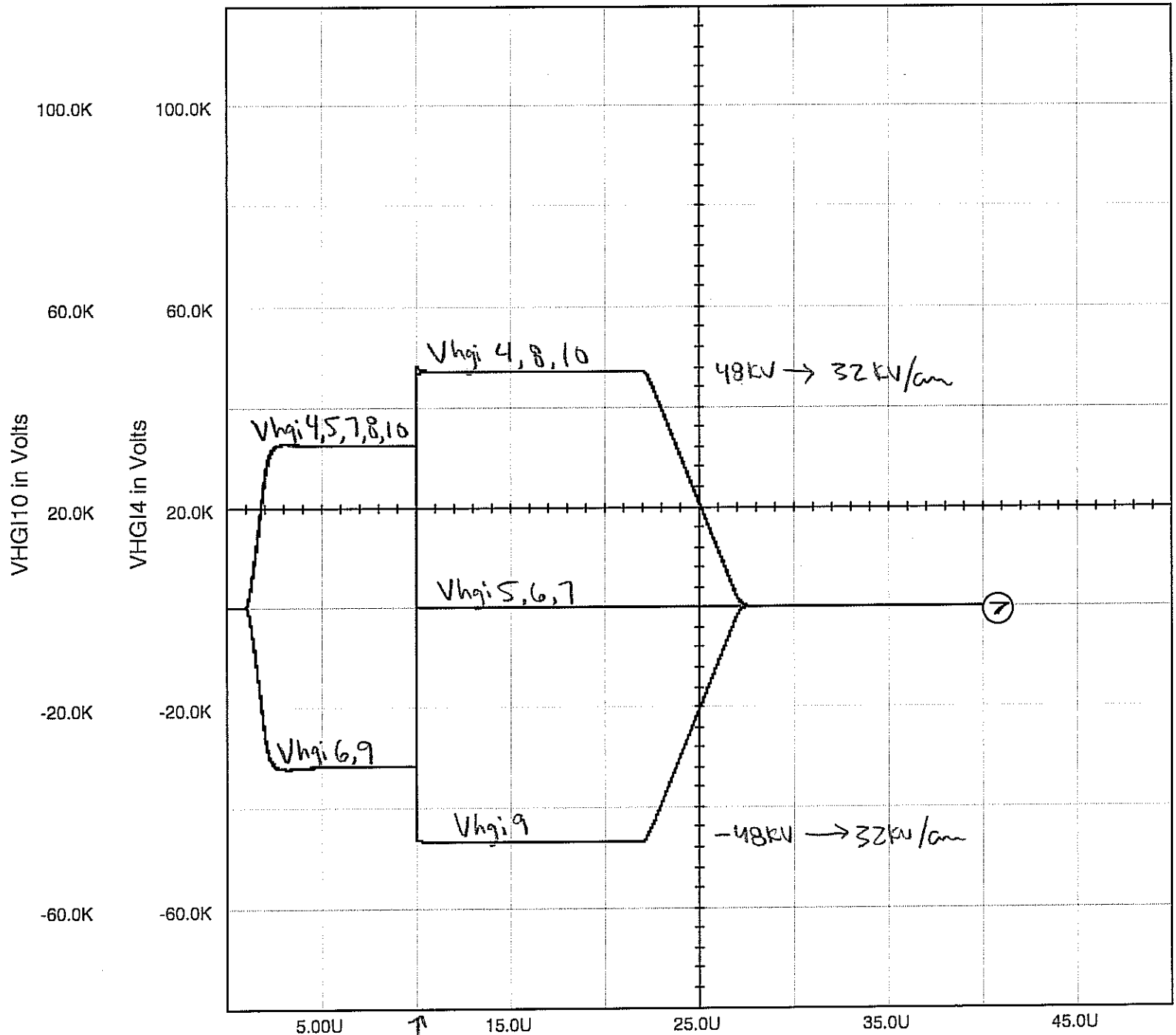

WFM.1 VHGI4 vs. TIME in Secs

↑
X7
close

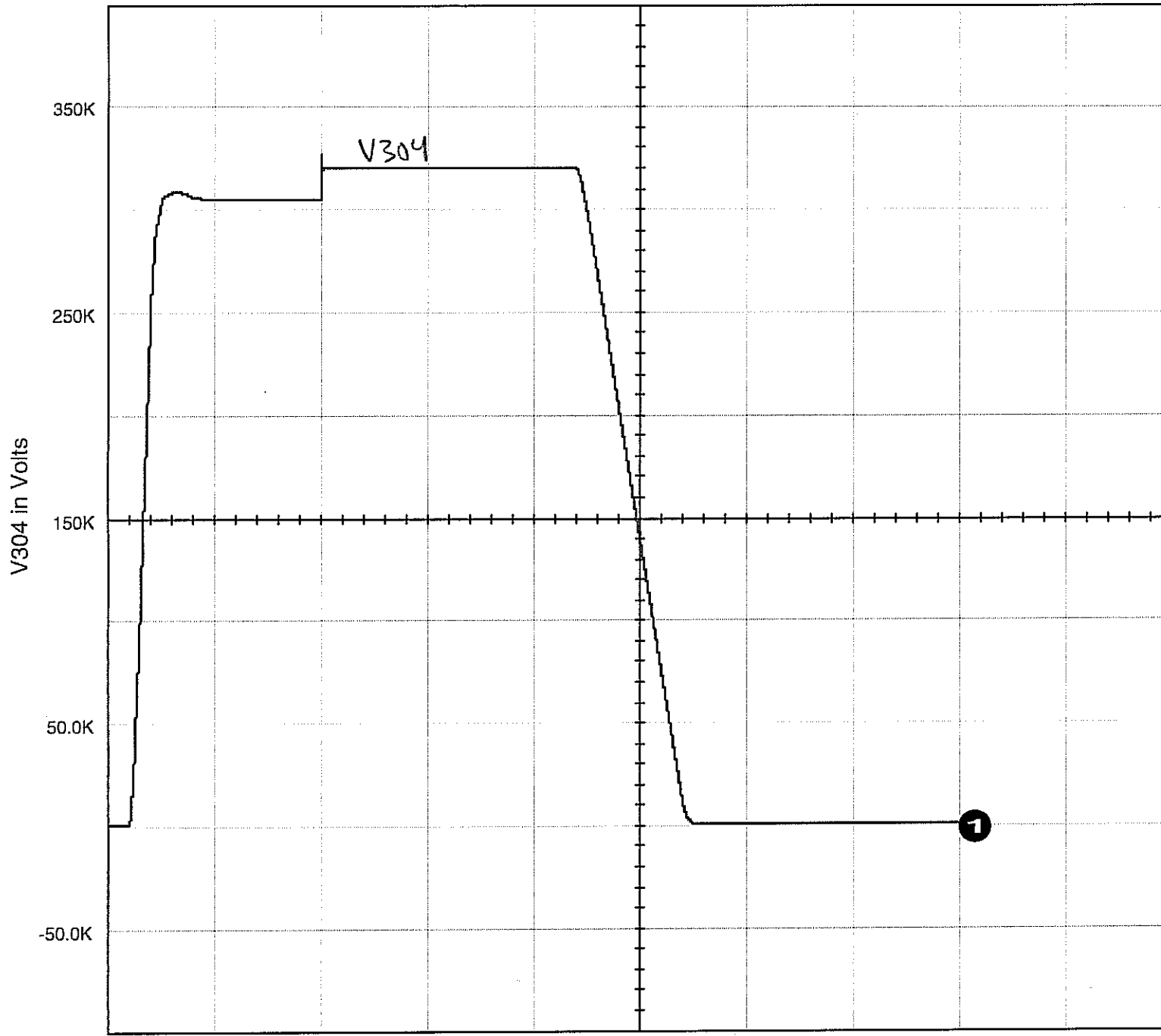

WFM.1 V304 vs. TIME in Secs

↑
X7
close

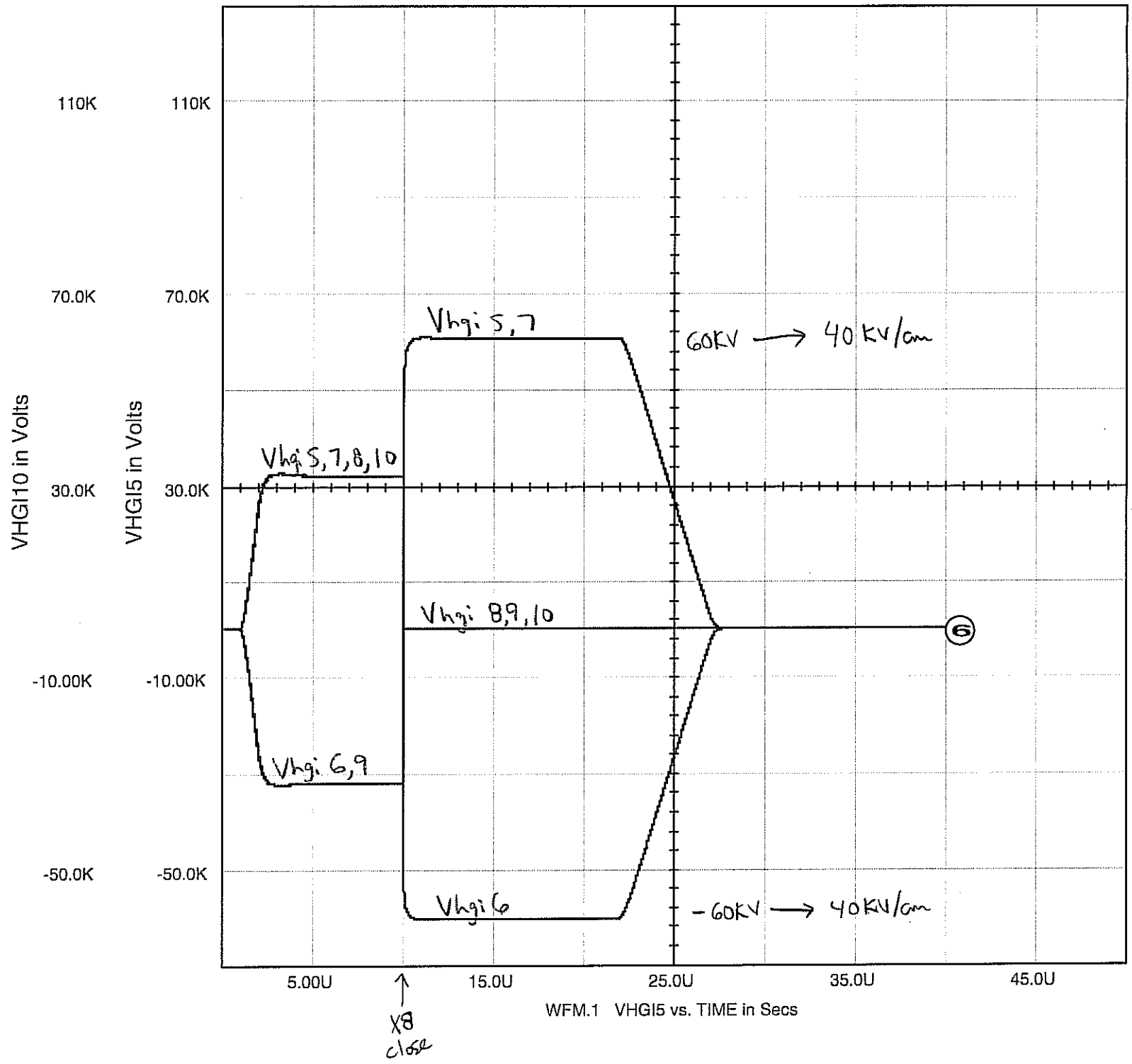

WFM.1 Vhgi5 vs. TIME in Secs

